

ITEM NO.	PART NUMBER	DESCRIPTION	QTY.
1	435-602	Slide Bedway	1
2	403-484	Ladder Hand Rail	2
3	383-302	Entrance Bar	1
4	103-306	Slide Leg	1
5	434-618	Platform Leg	4
6	403-488	Platform	1
7	403-510	Ladder	1
8	314-460	Slide Leg Holder	1
9	403-240	Platform Guard Rail	2
10			
11	415-513	1-3/8" T-Clamp	6pr
12	316-601	3/8" Flat Washer	6
13	116-530	5/16" x 1" Button Head Bolt	19
14	196-802	1/2" x 1/2" Socket Set Screw	6
15	116-604	3/8" x 1" Hex Head Bolt	6
16	326-601	3/8" Lock Washer	6
17	326-501	5/16" Lock Washer	15
18	316-501	5/16" Flat Washer	14
19	226-501	5/16" Lock Nut	6
20	216-512	5/16"x1" Button Head Nut	14
21	416-400	1/4" Socket Key	1
22	416-350	3/16" Socket Key	2
23	216-501	5/16" Hex Nut	3
24	805-532	Warning Label	1
25	805-534	SportsPlay Label	1
26	000-000	Maintenance Checklist	1

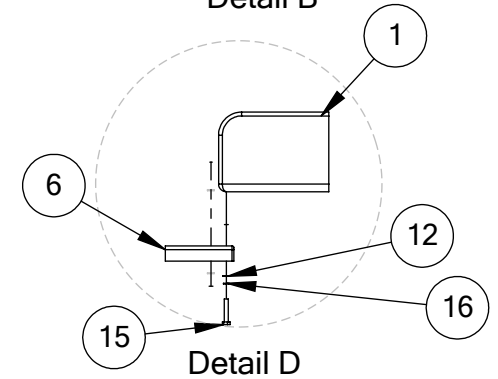

(DETAILS CONTINUED ON SHEET 2)

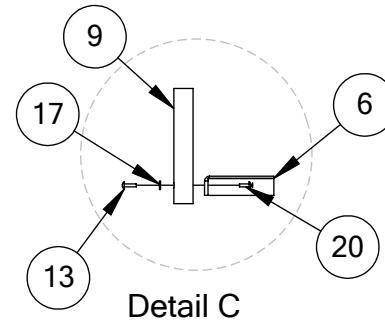
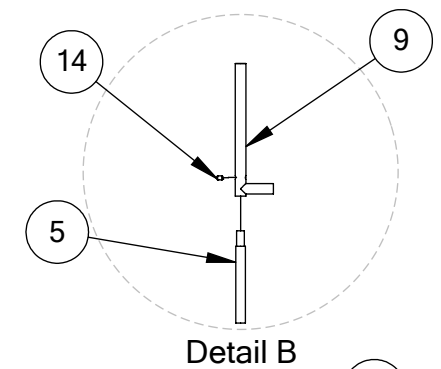
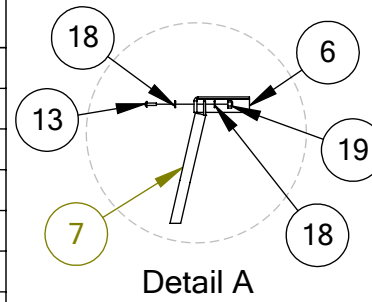
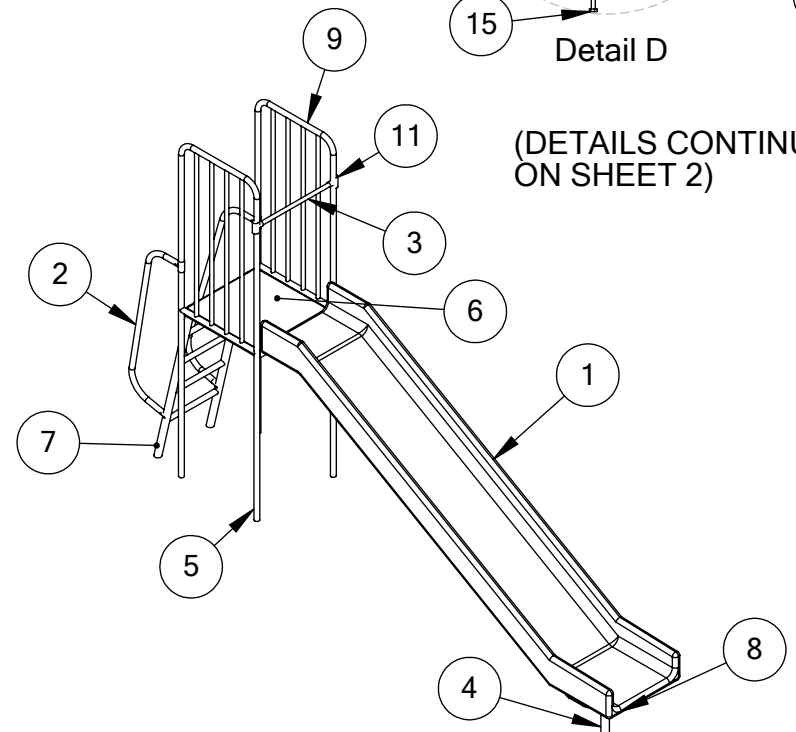

(DETAILS CONTINUED FROM SHEET 1)

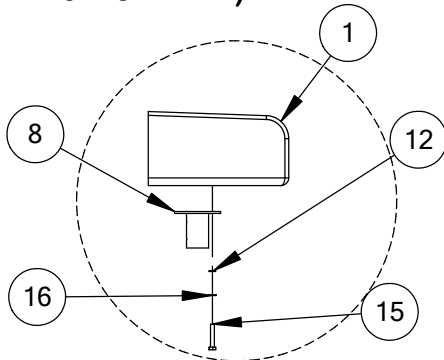

Detail E

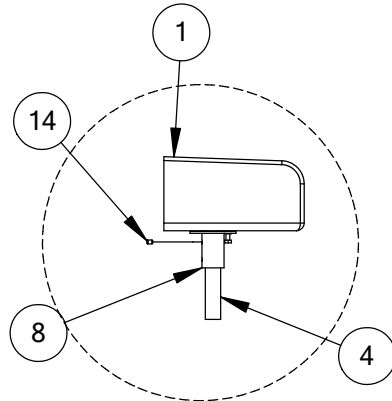

Detail F

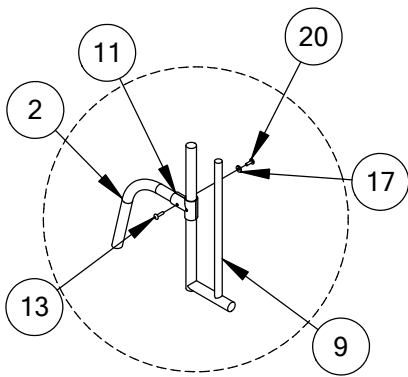

Detail G

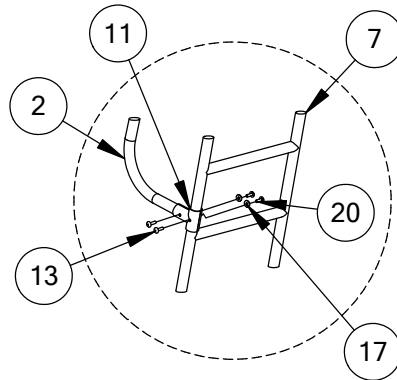

Detail H

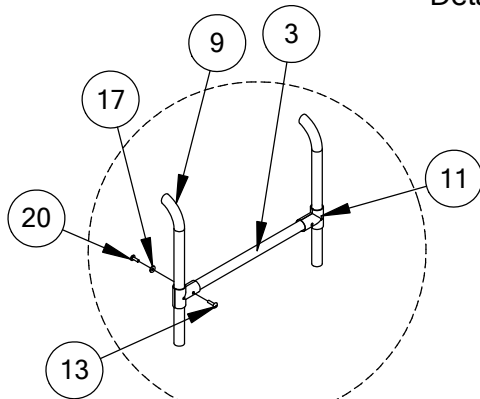

Detail I

IMPORTANT

Please read these instructions before commencing assembly. All equipment must be installed in accordance with these instructions. Check your shipment against Bill of Lading and Parts List. Any missing or broken parts must be reported to your distributor within 10 days of receipt of your order. When properly installed and maintained, equipment will give many years of Safe, Trouble-Free use. Periodically check for loose or broken parts. Loose bolts must be tightened and broken parts must be replaced as they can possibly create dangerous situations leading to unnecessary accidents. Resilient Surfacing should be used under all playground equipment. Appropriate publications, available at no charge, from the Consumer Product Commission, include "A Handbook for Public Playground Safety". You can receive your free copy by calling 1-301-504-7908.

GENERAL FOOTING RECOMMENDATIONS:

Stationary & Portable Equipment - Use/Fall Zones should extend a minimum of 6 feet in all directions from the perimeter of the equipment ground space. This area should be covered with the required amount of Resilient Safety Surfacing Material. For some Equipment Use/Fall Zones can Overlap. See Consumer Product Safety Commission Guidelines. Diameter and depth of footings illustrated are satisfactory in most applications for pipe sizes up to 2-3/8" diameter. Varying soil and climatic conditions may require deeper and heavier footings in some areas. Check local building codes.

Permanent Installations

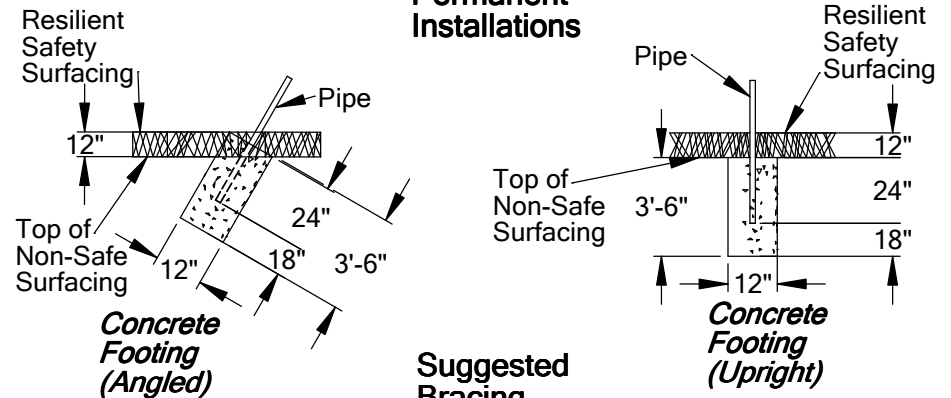

Suggested Bracing Method

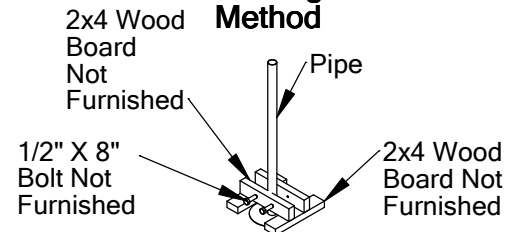

* If Resilient Surfacing is to be less than 12", then additional pipe should be put in concrete to maintain proper finish grade for equipment.*

USE AREA & FOOTING LAYOUT

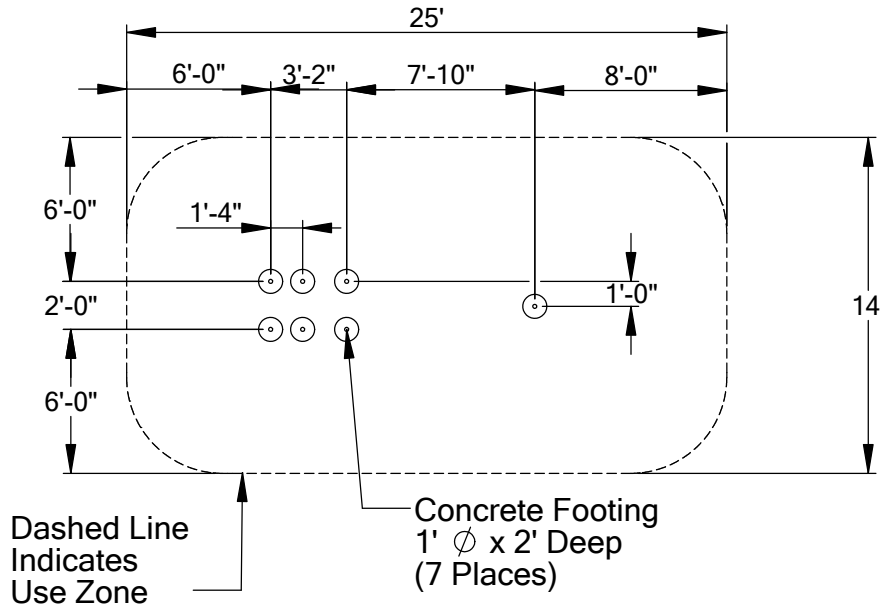

GENERAL MAINTENANCE INSTRUCTIONS:

Check MONTHLY for loose bolts, damaged or broken parts. Tighten and/or replace immediately.

GENERAL ASSEMBLY INSTRUCTIONS:

Only hand tighten nuts & bolts on initial assembly. Final tightening should be done EVENLY after final assembly when unit has been plumbed & leveled. After assembly is complete, ANY ENDS OF BOLTS PROTRUDING BEYOND NUTS SHOULD BE CUT OFF AND/OR PEENED OVER TO REMOVE ANY SHARP EDGES. T-Clamps are designed for both one and two bolt connections. In many situations only one bolt is required. See specific assembly instructions. Go over entire unit to file smooth any sharp edges or projections that may have been caused by rough handling in shipping or installation. On products with platforms install 1 -2 degrees off level to facilitate water drainage.

ASSEMBLY & INSTALLATION:

NOTE: Slide should be installed in shaded areas or face NORTH to prevent direct Sun on Slide's Chute.

1. Mark & dig footing holes per diagram.
2. Assemble entire slide lying unit on its side on the ground. Start by attaching Ladder to Platform. See Detail A.
3. Attach Platform Guard Rail to Platform Legs. See Detail B. Then attach Guard Rail Assy. To Platform. See Detail C.
4. Attach Slide Bedway to Platform. See Detail D.
5. Attach Leg Holder to Slide Bedway. See Detail E. Then Attach Slide Leg to Bedway. See Detail F.
6. Attach Ladder Hand Rail to Guard Rail & Ladder. See Detail G.
7. Attach Entrance Bar to Guard Rails. See Detail H.
8. Raise & brace unit in footing holes. Length of legs below intended level of Resilient Surfacing should be 24"
9. Plumb & Level. Tighten all nuts & bolts so that lock washers are flat. Pour Concrete. Wait 48 hrs before removing brace, installing Resilient Surfacing & using equipment.
10. Attach Warning Label and Manufacturers Identification Label to a clean surface. The Labels should be attached in a locations where they are clearly visible and legible and away from normal hand and foot placement areas. The Labels must be replaced if they become illegible, destroyed, or removed. Contact your distributor for replacement Labels.